

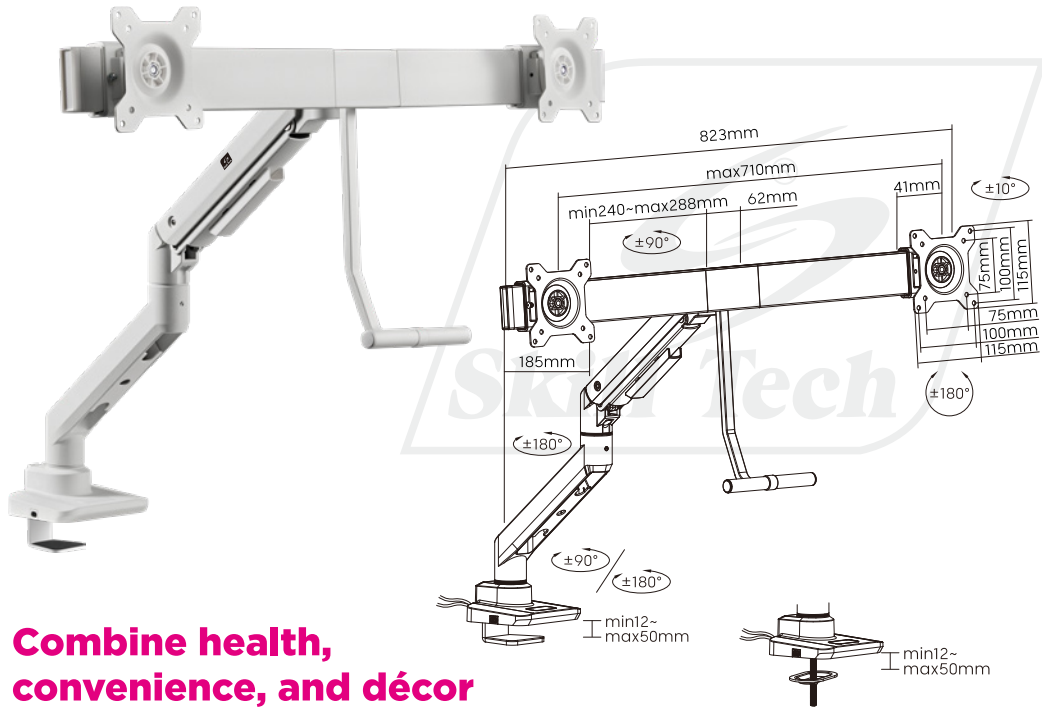









SH69 C022UC

Heavy-Duty Counterbalance Monitor Arm

Fits most 17"-32" flat & curved Monitors



-  Screen Size
17"-32"
-  VESA Compatible
75x75 100x100
-  **RATED**
 Weight Capacity
1-9kg/2.2-19.8lbs (x2)
-  Tilt Range
+10° - -10°
-  Swivel Range
+10° - -10°
-  Screen Rotation
+180° - -180°
-  Cable Management
-  Curved Monitor
-  **USB TYPE- C**
-  **USB TYPE- A**

Combine health, convenience, and décor in one solution.



Cable Management keeps everything organized.



Interactive handle allows to easily position monitors with one hand.